

Avvolgitori Uni

- 39.AA.05.10** - Capacità 6m Con placca interasse 14,2 - (B) 160
- 39.AA.05.11** - Capacità 6m Con placca interasse 16,5 - (B) 160
- 39.AA.05.20** - Capacità 6m Con placca interasse 18,5 - (B) 160
- 39.AA.05.21** - Capacità 6m Con placca interasse 20,5 - (B) 160
- 39.AA.05.30** - Capacità 12m Con placca interasse 14,2 - (B) 245
- 39.AA.05.31** - Capacità 12m Con placca interasse 16,5 - (B) 245
- 39.AA.05.40** - Capacità 12m Con placca interasse 18,5 - (B) 245
- 39.AA.05.41** - Capacità 12m Con placca interasse 20,6 - (B) 245



Placca interasse 142

- 39.AA.06.30** - Solo placca interasse - 14,2 - Alluminio Anod.
- 39.AA.06.40** - Solo placca interasse - 14,2 - Inox.
- 39.AA.06.41** - Solo placca interasse - 14,2 - Bianco 9010.



Placca interasse 165

- 39.AA.06.50** - Solo placca interasse - 16,5 - Alluminio Anod.
- 39.AA.06.60** - Solo placca interasse - 16,5 - Inox.
- 39.AA.06.61** - Solo placca interasse - 16,5 - Bianco 9010.

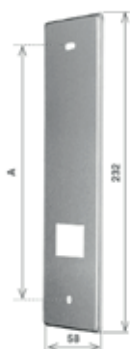

Placca interasse 184

- 39.AA.06.65** - Solo placca interasse - 18,4 - Alluminio Anod.
- 39.AA.06.70** - Solo placca interasse - 18,4 - Inox.
- 39.AA.06.75** - Solo placca interasse - 18,4 - Bianco 9010.



Placca interasse 205

39.AA.06.66 - Solo placca interasse - 20,6 - Alluminio Anod.

39.AA.06.71 - Solo placca interasse - 20,6 - Inox.

39.AA.06.76 - Solo placca interasse - 20,6 - Bianco 9010.

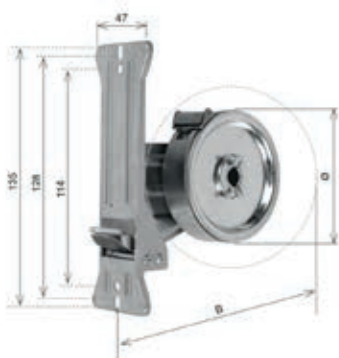

Avvolgitore Star per sostituzione

39.AA.04.80 - Capacità 4 m - Con plastica interasse 11,4 - (B) 135

39.AA.04.81 - Capacità 6 m - Con plastica interasse 12,8 - (B) 135



Placca

39.AA.06.25 - Solo placca interasse - 11,4 - Allum. Anod.

39.AA.06.27 - Solo placca interasse - 12,8 - Allum. Anod.

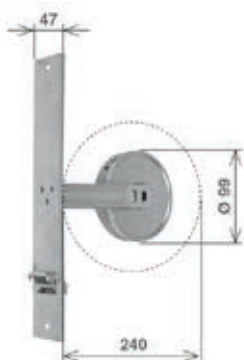

Avvolgitore "F" per sostituzioni

39.AA.05.45 - Capacità m.13 inter 26,0

39.AA.06.72 - Solo placca interasse - 26,0 - Inox



Placca cieca

- 39.AA.06.70C** - Placca cieca inox inter 18,5
- 39.AA.06.71C** - Placca cieca inox inter 20,5

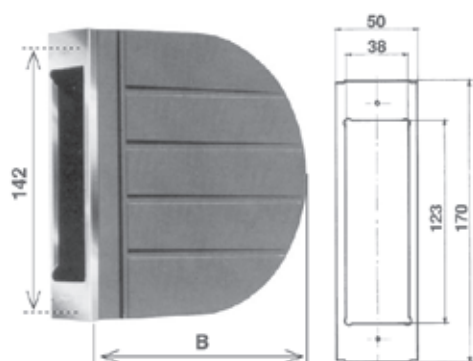

Cassetta in plastica

- 39.AA.07.00** - Capacità 6 m - (B) 165 mm
- 39.AA.07.10** - Capacità 12 m - (B) 250 mm



Avvolgitore esterno nichelato

- 39.AA.05.70** - Capacità 6m - (A) 256
- 39.AA.05.71** - Capacità 8m - (A) 256



Avvolgitore orientabile cromato

- 39.AA.05.80** - Capacità 6 m
- 39.AA.05.81** - Capacità 8 m



Cassetta in polistirolo antiurto

Colore avorio per avvolgitore orientabile da 6m

39.AA.07.50



Avvolgitore a cassetto + Puleggia

39.AA.05.90 - Destro

39.AA.06.00 - Sinistro

Puleggia Ø mm 210 - Puleggia Ø mm 142 - (I) 139

Cintino Ø mm 130 - Cintino L=m 3,5

Giri 6,5 - Portata Kg 20

(A) 268 - (B) 268 - (C) 20 - (D) 28 - (T) 308



Avvolgitore a cassetto + Riduttore

39.AA.06.10 - Destro

39.AA.06.20 - Sinistro

Rapporto 1:2,66

Puleggia Ø mm 115- (I) 142

Cintino Ø mm 170 - Cintino L=m 8,5

Giri 6,5 - Portata Kg. 35

(A)285 - (B)285 (c)20 - (D)28 - (T)325

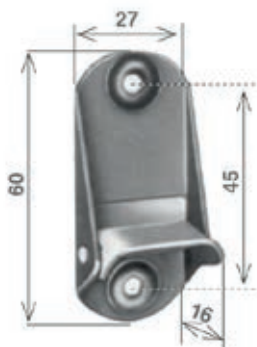

Bloccacintino

Bloccacintino per avvolgitori a cassetto

39.AA.14.00 - Zincato o bronzo

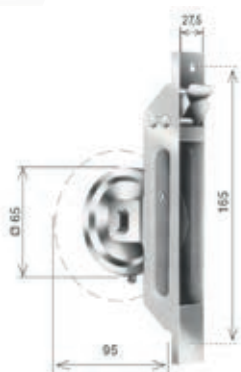

Avvolgitore a semincasso "S" 5m

Avvolgitore a semincasso "S" 5m esclusivamente per monoblocco

39.AA.05.50 - Zincato - H max 2,50 m
0 max pul 220 - cintino 22x1,7



Placca

Placca per avvolgitore a semincasso "S" 5m esclusivamente per monoblocco

39.AA.06.80 - Allum Anod.
39.AA.06.86 - Bianco 9010
39.AA.06.85 - Nero 9005

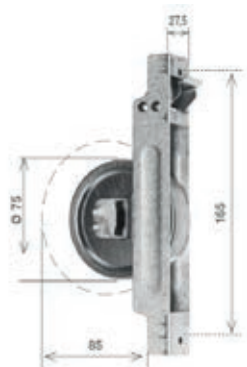

Avvolgitore a semincasso "SR" 8m

Avvolgitore a semincasso "SR" 8m esclusivamente per monoblocco con riduttore

39.AA.05.60 - Zincato - H max 2,50 m



Placca "SR" 8m

Placca per avvolgitore "SR" 8 m

39.AA.06.90 - Allumin. Anod
39.AA.06.92 - Bianco 9010
39.AA.06.91 - Nero 9005

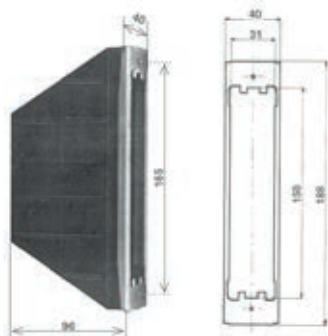

Cassetta in plastica per monoblocco aperto

Cassetta in plastica per avvolgitori a semincasso per profilo monoblocco aperto
[39.AA.07.20](#)



Cassetta in plastica per monoblocco scatolato

Cassetta in plastica a inserimento frontale per avvolgitori a semincasso
(per profilo monoblocco scatolato)
[39.AA.07.40](#)